

Data Sheet

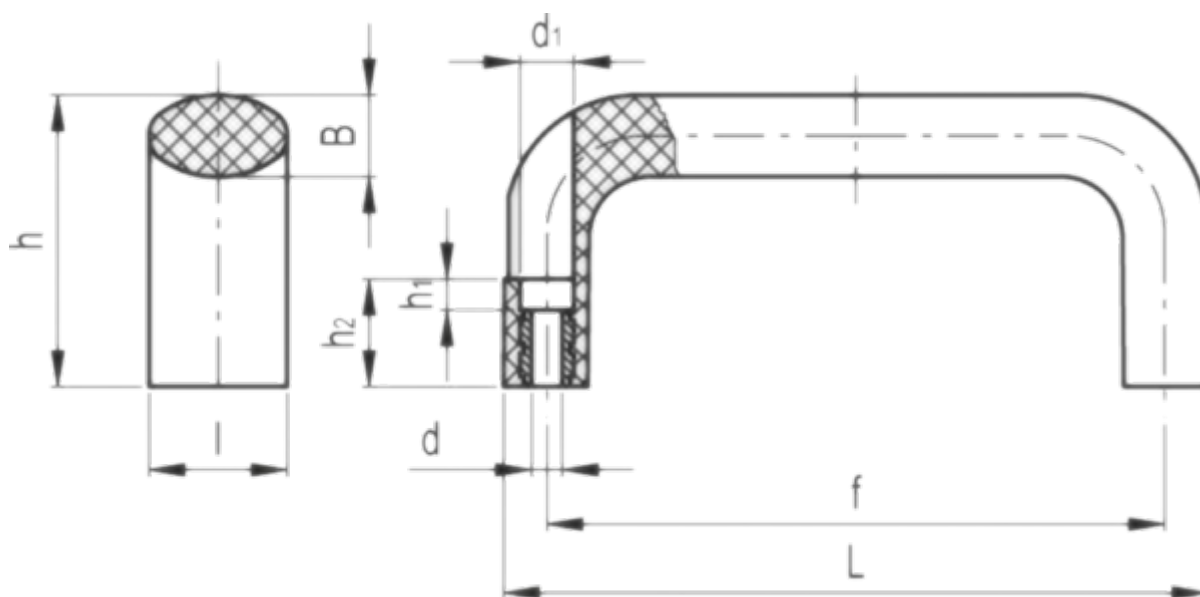

Article number: 2304137301
Description: E+G Handle
M.643 FM/100 B-5

Measures



$B = 14$	$h_2 = 20.5$
$d = 5.4$	$l = 23$
$d_1 = 8.5$	$L = 100$
$f = 86 \pm 0.5$	$L_1 = 11$
$F_1 = 3000$	$L_2 = 9$
$F_2 = 2200$	Weight in (g) = 45
$h = 44$	
$h_1 = 5.5$	